

- **Style: Simple**
- **Size: Mid Tower supports up to E-ATX MB**
- **Material: Steel & Tempered Glass x 2**

Main Features

- **Connection** : Front I/O ports with 2 x USB 3.0 & 1 x USB 3.2 (Gen 2) Type C
- **Ventilation** : Pre-installed 120mm ARGB Lite fan x 3
- **Supports** : Supports AIO/DIY cooling solutions





Thermaltake View 270 Plus TG ARGB Mid Tower Chassis

Specification

Model	View 270 Plus TG ARGB	View 270 Plus TG ARGB Snow	View 270 Plus TG ARGB Matcha Green	View 270 Plus TG ARGB Hydrangea Blue	View 270 Plus TG ARGB Bubble Pink
P/N	CA-1Y7-00M1WN-01	CA-1Y7-00M6WN-01	CA-1Y7-00MEWN-01	CA-1Y7-00MFWN-01	CA-1Y7-00MAWN-00
Case Type	Mid Tower				
Chassis Dimension (H*W*D)	456 x 230 x 454 mm (18 x 9.1 x 17.9 inch)				
Net Weight	6.35 kg / 14 lbs.				
Panel	Tempered Glass x 2				
Color	Black	White	Matcha Green	Hydrangea Blue	Bubble Pink
Material	SPCC				
Cooling System	Right(intake): 120 x 120 x 25 mm ARGB Lite fan (1000rpm, 22.3 dBA) x 2 Rear(exhaust): 120 x 120 x 25 mm ARGB Lite fan (1000rpm, 22.3 dBA) x 1				
Drive Bays	2 x 3.5", 1 x 2.5" or 2 x 2.5"				
Expansion Slots	7				
Motherboards	6.7" x 6.7" (Mini ITX), 9.6" x 9.6" (Micro ATX), 12" x 9.6" (ATX), 12" x 13" (E-ATX)				
I/O Port	USB 3.2 (Gen 2) Type-C x 1, USB 3.0 x 2, HD Audio x 1				
PSU	Standard PS2 PSU (optional)				
Fan Support	Top: 3 x 120mm, 2 x 120mm, 1 x 120mm 2 x 140mm, 1 x 140mm Right (M/B Side): 2 x 120mm, 1 x 120mm Rear: 1 x 120mm, 1 x 140mm Power Cover: 3 x 120mm, 2 x 120mm, 1 x 120mm				
Radiator Support	Top: 1 x 360mm, 1 x 240mm, 1 x 120mm Rear: 1 x 120mm				
Clearance	CPU cooler max height: 180mm VGA max length: 420mm PSU max length: 220mm				



Thermaltake View 270 Plus TG ARGB Mid Tower Chassis

Packaging

Package Information	View 270 Plus TG ARGB	View 270 Plus TG ARGB Snow	View 270 Plus TG ARGB Matcha Green	View 270 Plus TG ARGB Hydrangea Blue	View 270 Plus TG ARGB Bubble Pink
EAN Code	4711475644182	4711475644199	4711475644205	4711475644212	4711475645806
UPC Code	841163094198	841163094204	841163094211	841163094228	841163095812
N.W	6.35 kg / 14 lbs.				
G.W	7.65 kg / 16.87 lbs.				
Carton Size (L x W x H)	525 x 290 x 515 mm / 20.67 x 11.42 x 20.28 inch				
Cuft	2.77				
Container	w/o pallet, w/ spare parts				
20'	379 pcs				
40'	779 pcs				
40' HQ	876 pcs				





Thermaltake View 270 Plus TG ARGB Mid Tower Chassis

Appearance –
Black version



Angle view



Left Side view



Front view



Right Side view



Internal Structure



Rear view



Top view



Bottom view



Thermaltake View 270 Plus TG ARGB Mid Tower Chassis

Appearance –
Snow version



Angle view



Left Side view



Front view

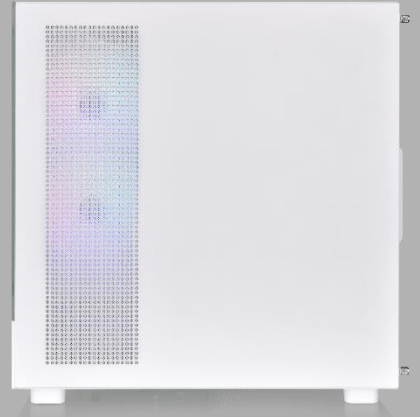

Right Side view



Internal Structure



Rear view



Top view



Bottom view



Thermaltake View 270 Plus TG ARGB Mid Tower Chassis

Appearance –
Matcha Green



Angle view



Left Side view



Front view

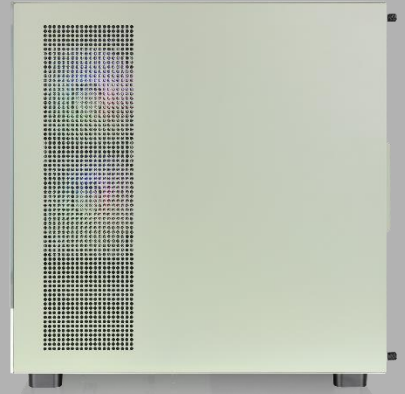

Right Side view



Internal Structure



Rear view



Top view



Bottom view



Thermaltake View 270 Plus TG ARGB Mid Tower Chassis

Appearance –
Hydrangea Blue



Angle view



Left Side view



Front view

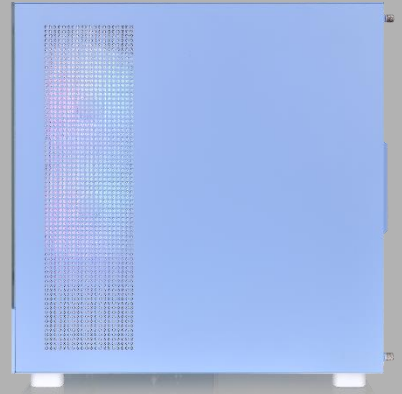

Right Side view

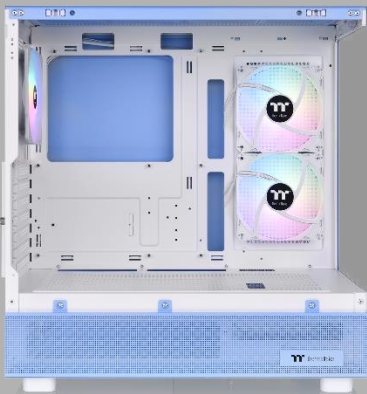

Internal Structure



Rear view

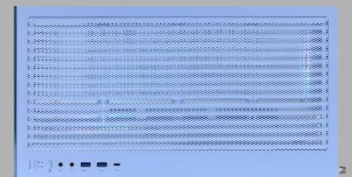

Top view



Bottom view



Thermaltake View 270 Plus TG ARGB Mid Tower Chassis

Appearance –
Bubble Pink



Angle view



Left Side view



Front view



Right Side view



Internal Structure



Rear view

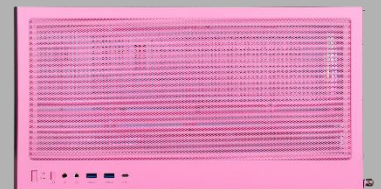

Top view



Bottom view



Thermaltake View 270 Plus TG ARGB Mid Tower Chassis

Clearance



Maximum support up
to 120mm fan x 9



Maximum radiator support
up to 360mm on the top



Thermaltake View 270 Plus TG ARGB Mid Tower Chassis

Structure (External)



USB 3.2 (Gen 2) Type-C x 1

USB 3.0 x 2

HD Audio



**4mm Front Tempered
Glass Window x 1**

**3mm Side Tempered
Glass Window x 1**

Structure (Internal)

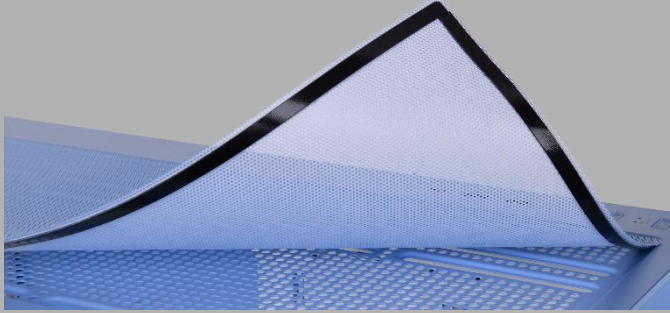

Top filter

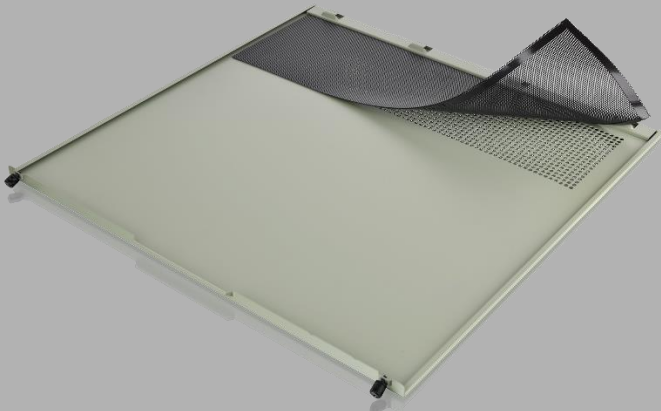

Right side filter



Bottom filter



Thermaltake View 270 Plus TG ARGB Mid Tower Chassis

Structure (Internal)

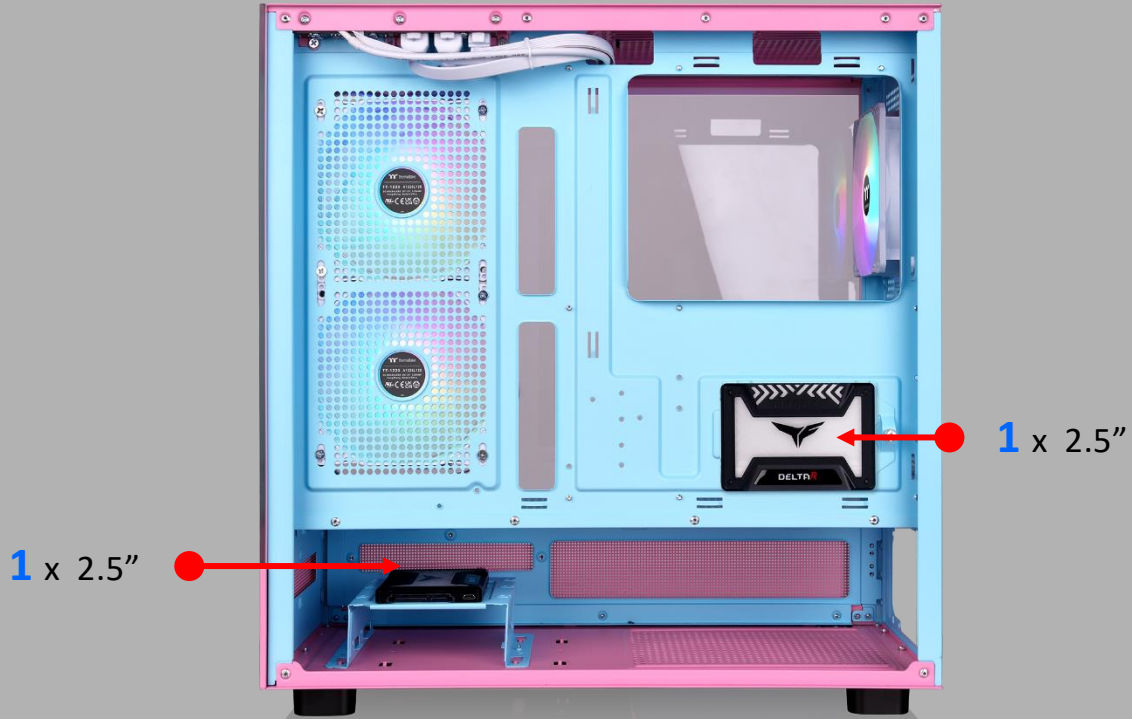

It can support up to 2 x 2.5" SSD



It can support up to 2 x 3.5" HDD



Thermaltake View 270 Plus TG ARGB Mid Tower Chassis

Structure (Internal)



Full length power cover



3 x 120mm Fan on the power cover



Thermaltake View 270 Plus TG ARGB Mid Tower Chassis

Pre-installed ARGB Lite Fans

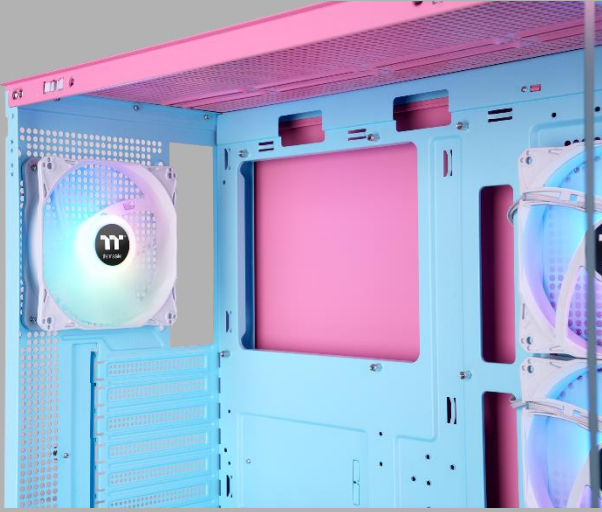

Pre-installed three hydraulic bearing ARGB **Lite** fans which can effectively lower the operation noise and enhance the thermal efficiency.



Black/Matcha
Green Version



Snow/Hydrangea Blue Version

SPEC for Case ARGB **Lite** fans

- Fan Speed: 1000 +/- 200 RPM
- Fan Airflow: 35.25 CFM
- Fan Air Pressure: 0.54 mm-H₂O
- Fan Noise Level: 22.3 dBA
- Fan Bearing: Hydraulic bearing

Compatibility List

Fan Compatibility List			
	120mm	140mm	200mm
Top	3	2	-
Right(M/B Side)	2	-	-
Rear	1	1	-
Power Cover	3	-	-

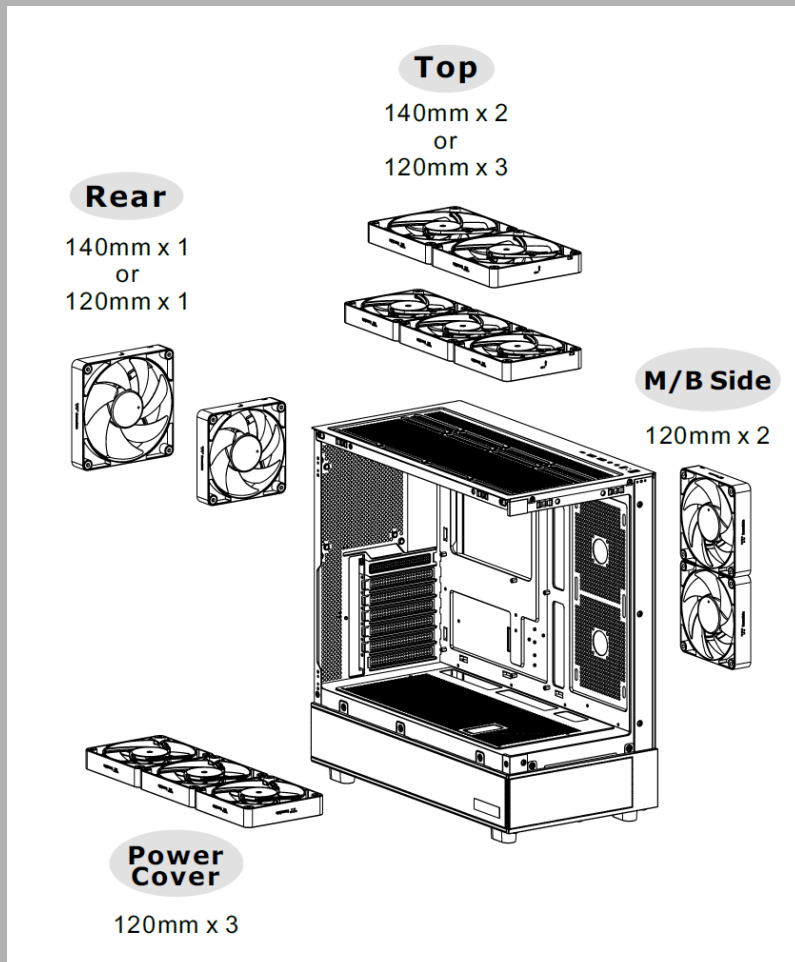



Thermaltake View 270 Plus TG ARGB Mid Tower Chassis

All-in-One Compatibility

All-in-One Compatibility List						
	120mm	240mm	360mm	140mm	280mm	420mm
Top	●	●	●	-	-	-
Rear	●	-	-	-	-	-

