

- **Style: Simple**
- **Size: Mid Tower supports up to E-ATX MB**
- **Material: Steel & Tempered Glass**

Main Features

- **Connection: Front I/O ports with USB 3.0 x 2**
- **Ventilation: Preinstalled 120mm ARGB PWM fan x 3**
- **Support: Supports AIO cooling solutions**



Specification

Model	Divider 370 TG ARGB	Divider 370 TG Snow ARGB
P/N	CA-1S4-00M1WN-00	CA-1S4-00M6WN-00
Case Type	Mid Tower	
Chassis Dimension (H*W*D)	491 x 220.3 x 469.1 mm (19.3 x 8.7 x 18.5 inch)	
Net Weight	7.44 kg / 16.4 lbs.	
Panel	3mm Tempered Glass x 1	
Color	Black	White
Material	SPCC	
Cooling System	Front(intake): 120 x 120 x 25 mm ARGB PWM fan (1500rpm, 27.2 dBA) x 2 Rear(exhaust): 120 x 120 x 25 mm ARGB PWM fan (1500rpm, 27.2 dBA) x 1	
Drive Bays	2 x 3.5", 2 x 2.5" or 4 x 2.5"	
Expansion Slots	7	
Motherboards	6.7" x 6.7" (Mini ITX), 9.6" x 9.6" (Micro ATX), 12" x 9.6" (ATX), 12" x 13" (E-ATX)	
I/O Port	USB 3.0 x 2, HD Audio x 1	
PSU	Standard PS2 PSU (optional)	
Fan Support	Front: 3 x 120mm, 2 x 120mm, 1 x 120mm 3 x 140mm, 2 x 140mm, 1 x 140mm Top: 3 x 120mm, 1 x 120mm 2 x 140mm, 1 x 140mm Right (M/B Side): 2 x 120mm, 1 x 120mm Rear: 1 x 120mm	
Radiator Support	Front: 1 x 360mm, 1 x 240mm, 1 x 120mm 1 x 280mm, 1 x 140mm Top: 1 x 360mm, 1 x 240mm, 1 x 120mm 1 x 280mm, 1 x 140mm Right (M/B Side): 1 x 240mm, 1 x 120mm Rear: 1 x 120mm	
Clearance	CPU cooler max height: 170mm VGA max length: 340mm (with radiator) 400mm (without radiator) PSU max length: 230mm (with HDD Cage)	

Packaging

Package Information	Divider 370 TG ARGB	Divider 370 TG ARGB Snow
EAN Code	4713227525718	4713227527873
UPC Code	841163075722	841163077887
N.W	7.44 kg / 16.4 lbs.	
G.W	8.86 kg / 19.5 lbs.	
Carton Size (L x W x H)	575 x 322 x 568 mm / 22.6 x 12.7 x 22.4 inch	
Cuft	3.71	
Container	w/o pallet	
20'	280 pcs	
40'	576 pcs	
40' HQ	656 pcs	





Thermaltake Divider 370 TG ARGB Mid Tower Chassis

Appearance –
Black version



Angle view



Left Side view



Front view



Right Side view



Internal Structure



Rear view



Top view

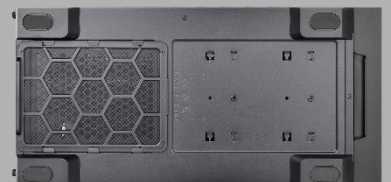

Bottom view



Thermaltake Divider 370 TG ARGB Mid Tower Chassis

Appearance –
Snow version



Angle view



Left Side view



Front view



Right Side view



Internal Structure



Rear view

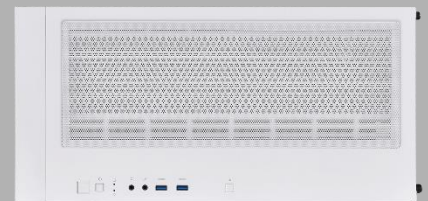

Top view



Bottom view



Thermaltake Divider 370 TG ARGB Mid Tower Chassis

Clearance



Maximum radiator support
up to 360mm at front

Unique Design



Unique Side Panel Design



Thermaltake Divider 370 TG ARGB Mid Tower Chassis

Features



USB 3.0 x 2

HD Audio



Horizontal VGA
Bracket installation



Vertical VGA
Bracket installation



↑ VGA bracket
supports vertically
installation



Thermaltake Divider 370 TG ARGB Mid Tower Chassis

Structure (External)



Top filter



Bottom filter



Right side filter



Thermaltake Divider 370 TG ARGB Mid Tower Chassis

Pre-installed
ARGB PWM Fans



Pre-installed three hydraulic bearing 120mm ARGB PWM fans which can effectively lower the operation noise and enhance the thermal efficiency.



Divider 370 TG ARGB

SPEC for Case ARGB PWM fans

- Fan Speed: 500~1500 RPM
- Max. Fan Airflow: 56.1 CFM
- Max. Fan Air Pressure: 1.11 mm-H₂O
- Fan Noise Level: 27.2 dBA
- Fan Bearing: Hydraulic bearing



Divider 370 TG ARGB Snow

ARGB lighting Control Instruction

I/O Port



- Wave Mode** Mode 1
- Flow Mode** Mode 2
- RGB Lighting** Mode 3 (Single Color)
- Radar Mode** Mode 4~10
(Red, Yellow, Green, Cyan, Blue, White, Purple)
- Breath Mode** Mode 11~18
(RGB, Red, Yellow, Green, Cyan, Blue, White, Purple)
- Full Lighted Mode** Mode 19
- Single Color** Mode 20~26
(Red, Yellow, Green, Cyan, Blue, White, Purple)
- Light Off** Mode 27

※ Long press on RGB button for 3 seconds, fan will blink twice which now are controlled by MB software. And vice versa.

How to connect MB

ASUS/ASRock/BIOSTAR

Aura Addressable Strip Header(s)

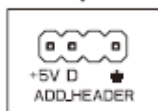
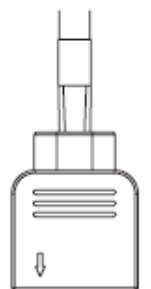

MSI

JRGB-strip Header(S)

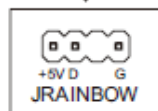

GIGABYTE

AOURS RGB Fusion with Digital LEDs

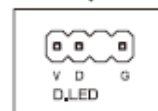

Compatibility List

Fan Compatibility List			
	120mm	140mm	200mm
Front	3	3	-
Top	3	2	-
M/B Side	2	-	-
Rear	1	-	-

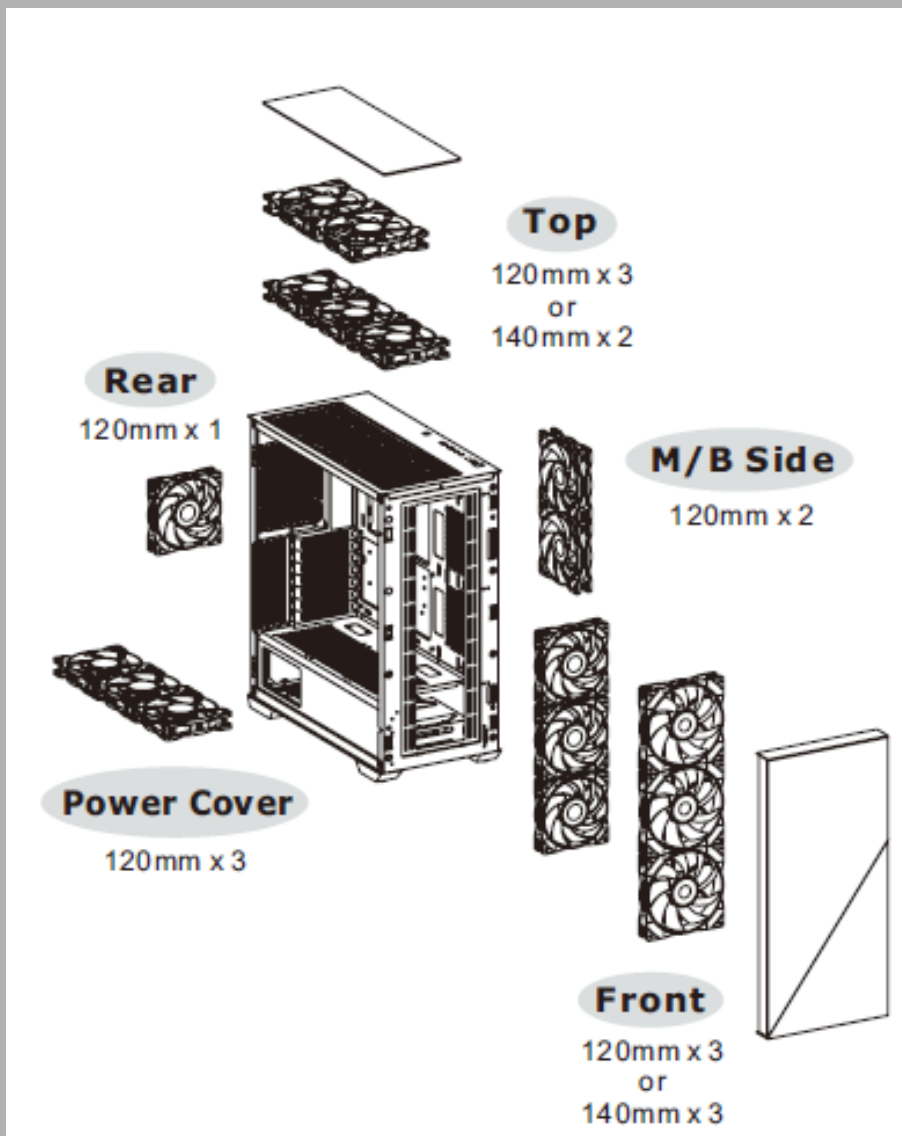

All-in-One Compatibility

All-in-One Compatibility List						
	120mm	240mm	360mm	140mm	280mm	420mm
Front	●	●	●	●	●	-
Top	●	●	●	●	●	-
M/B Side	●	●	-	-	-	-
Rear	●	-	-	-	-	-

