

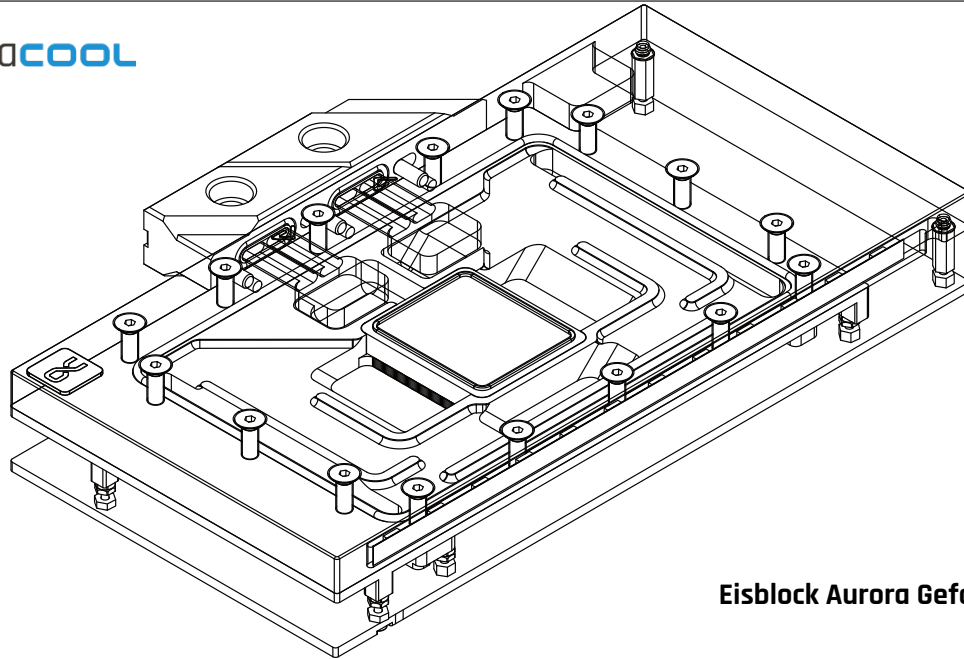

alphacool



Alphacool  
**Eisblock Aurora GeForce RTX 4090 AMP**  
with Backplate



Safety instructions  
Sicherheitshinweise  
Avis de sécurité



Digital guide  
Digitale Anleitung  
Guide digital



EN

Accessories

DE

Zubehör

FR

Accessoires

**A**

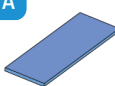

2x  
50x15x1mm  
Pad

**B**



2x  
100x8x1mm  
Pad

**C**

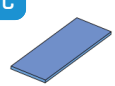

1x  
40x15x1mm  
Pad

**D**



4x  
5x5x1mm  
Pad

**E**



1x  
15x15x1mm  
Pad

**F**



1x  
Thermal grease

**G**



1x  
Putty tool

**H**



4x  
EVA Washer

**I**



4x  
M2x5mm  
Screw

**J**



1x  
15x15x3mm  
Pad

**K**



2x  
50x15x3mm  
Pad

**L**

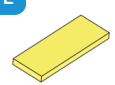

1x  
40x15x3mm  
Pad

**M**



2x  
103x8x3mm  
Pad

**N**

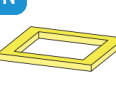

1x  
45x45x3mm  
GPU-Pad

**O**



1x  
PCI Bracket

**P**



8x  
M2x11mm  
Screw

**Q**



1x  
ARGB  
Adapter

**R**



1x  
Plug tool

**S**



2x  
G1/4 Plug

**Check compatibility**

Before starting the cooler assembly, compare your card with the pictures in our configurator. To do so, visit <https://www.hwconfig.com> and search for your graphics card or cooler model. For a definitiv identification, you can also compare the PCB number. The cooler was designed for a special PCB layout. Occasionally, graphics card manufacturers may revise the design of their card slightly, causing the cooler not to fit on later models. During assembly, please make sure taller parts have enough space around them and that the cooler does not damage your graphics card.

Alphacool International GmbH is not liable for assembly errors occurring due to negligence, such as selecting an incompatible cooler.

**Kompatibilität prüfen**

Bevor Sie mit der Montage des Kühlers beginnen, vergleichen Sie Ihre Platine mit den Fotos in unserem Konfigurator. Besuchen Sie dafür <https://www.hwconfig.com> und suchen Sie nach Ihrem Grafikkarten- oder Kühlermodell. Zur eindeutigen Zuordnung kann dort auch die PCB Nummer verglichen werden. Der Kühler wurde für ein spezielles PCB Layout konstruiert. Es kommt vor, dass Grafikkartenhersteller über Revisionen den Aufbau leicht abändern und der Kühler auf spätere Modelle nicht mehr passt. Achten Sie auch bei der Montage darauf, dass hohe Bauteile frei liegen und der Kühler die Grafikkarte nicht beschädigt.

Alphacool International GmbH haftet nicht bei fahrlässigen Montagefehlern, wie die Wahl eines inkompatiblen Kühlers.

**Vérification de compatibilité**

Avant de commencer l'assemblage du refroidisseur comparez votre carte avec les images de notre configurateur. Pour ce faire, visitez <https://www.hwconfig.com> et cherchez votre carte graphique ou votre modèle de refroidisseur. Pour une identification précise, vous pouvez également comparer le numéro de la PCB. La refroidisseur a été conçu pour une disposition spéciale du PCB. Il est possible que le fabricant change des détails dans la disposition de ses composants lors d'une révision et que le bloc de refroidissement ne soit plus compatible. Veillez lors de l'installation au fait que les composants hauts ne touchent pas le bloc de refroidissement et que le bloc n'endommage pas la carte graphique.

Alphacool International GmbH n'est pas responsable ni des erreurs d'installation ni du choix d'un refroidisseur incompatible.

**Prepare graphics card**

Put the hardware on an antistatic mat. Begin dismantling the original cooler. Depending on the structure of the cooler, remove the screws at the back of the card and carefully unhook the fan connector first. If the original cooler uses thermal glue, extreme care should be taken as you can easily damage parts. Pick up all the items carefully. Next, clean the hardware of thermal paste or pad residues with a solvent (e.g. isopropanol alcohol).

**Grafikkarte vorbereiten**

Legen Sie die Hardware auf eine antistatische Unterlage. Beginnen Sie mit der Demontage des Original-Kühlers. Je nach Aufbau des Kühlers sind zuerst die Schrauben des Lüfters zu entfernen und die Blenden zu lösen. Bei aufgeklebten Kühlern ist äußerste Sorgfalt geboten. Es können leicht Bauteile abgerissen werden. Heben Sie alle Einzelteile sorgfältig auf. Reinigen Sie anschließend die Hardware von Resten der Wärmeleitpaste oder Pads mit einem Lösemittel (z.B. Isopropanol-Alkohol).

**Préparer la carte graphique**

Posez le matériel sur un tapis antistatique. Commencez par le démontage du refroidisseur d'origine. Selon la configuration du radiateur les vis du ventilateur et les caches doivent être enlevés d'abord. S'il s'agit d'un refroidisseur collé il faut travailler très doucement. Sinon des composants peuvent s'arracher. Conservez tous les pièces soigneusement. Ensuite, nettoyer le matériel de résidus de la pâte thermique ou de pads avec un solvant (alcool isopropanol par ex.).

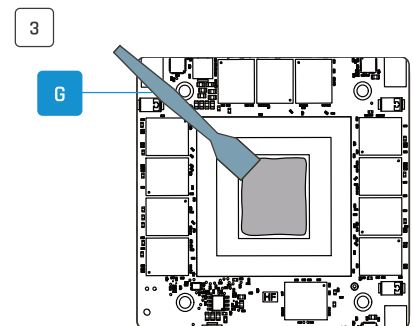
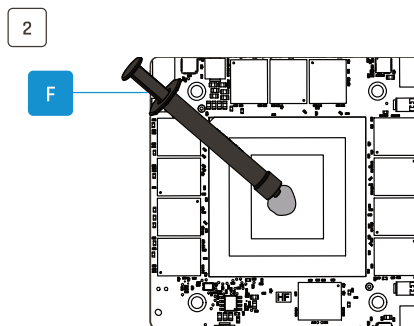
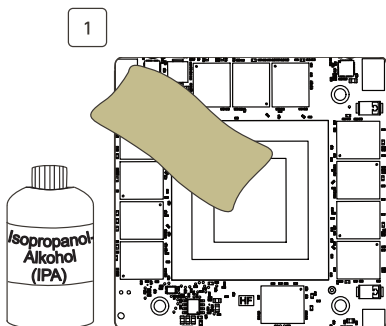
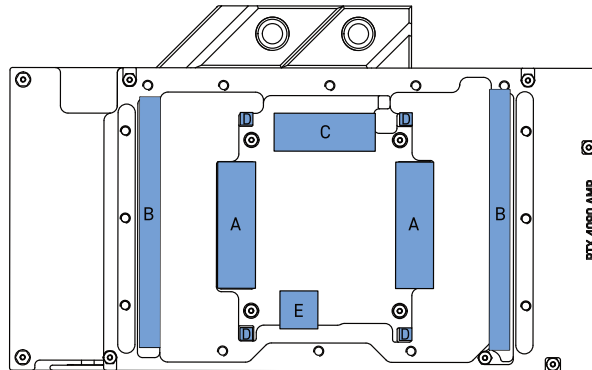
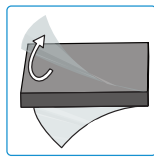

EN

Install PCB

DE

Installiere PCB

FR

Installer PCB

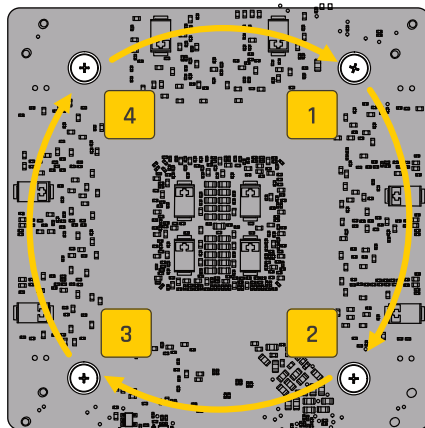
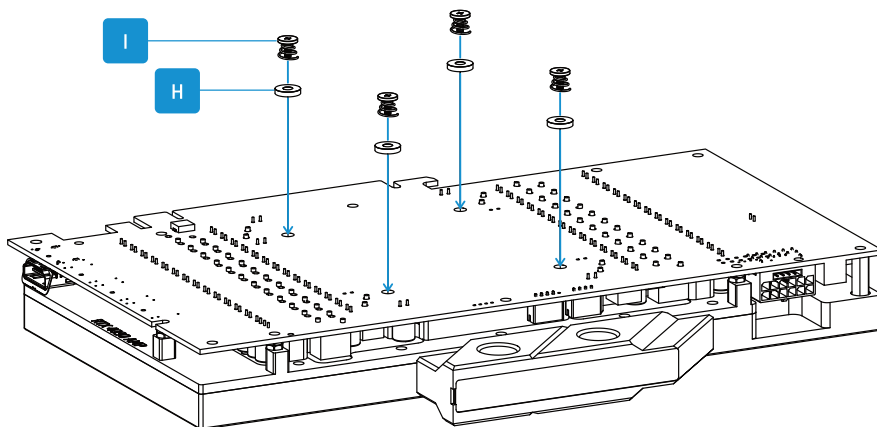

EN

Place thermal pads on PCB backside

DE

Wärmeleitpads auf der PCB Rückseite platzieren

FR

Placer les pads thermique sur la PCB au dos

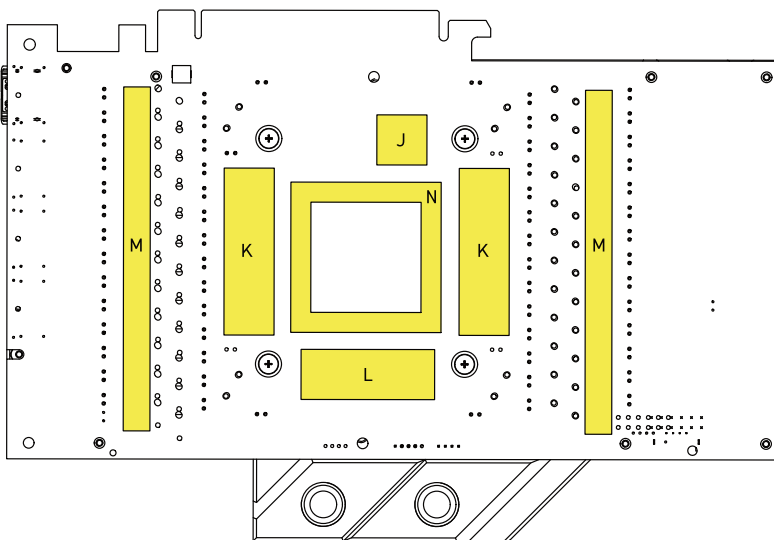
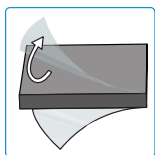

EN

Mount PCI bracket and backplate

DE

PCI Slotblende und Backplate montieren

FR

Monter le couvercle PCI et la plaque arrière

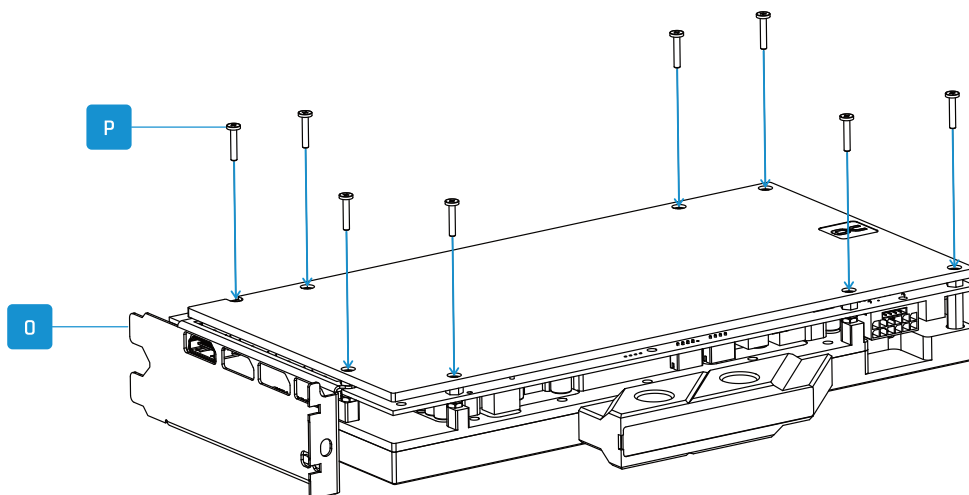

EN

Connect ARGB lighting

DE

ARGB Beleuchtung anschließen

FR

Connecter l'éclairage ARGB

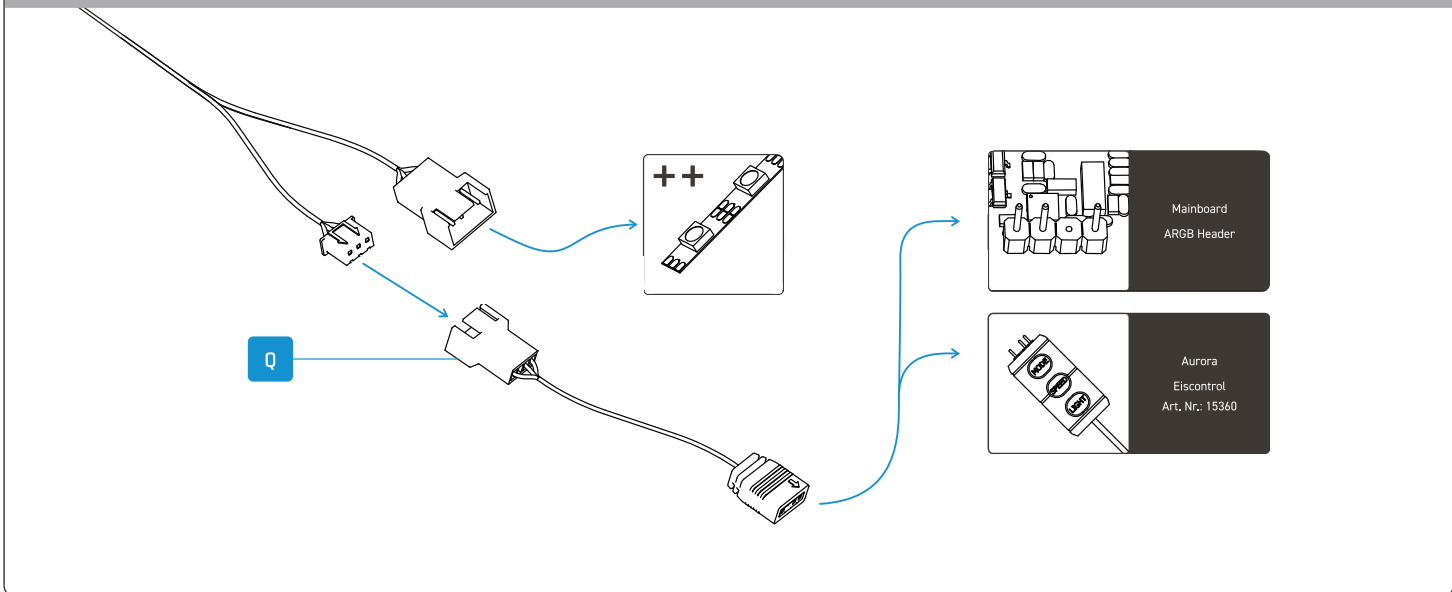

EN

Screw in screw plugs with the tool

DE

Verschlusschrauben eindrehen

FR

Visser les vis de fermeture avec l'outil

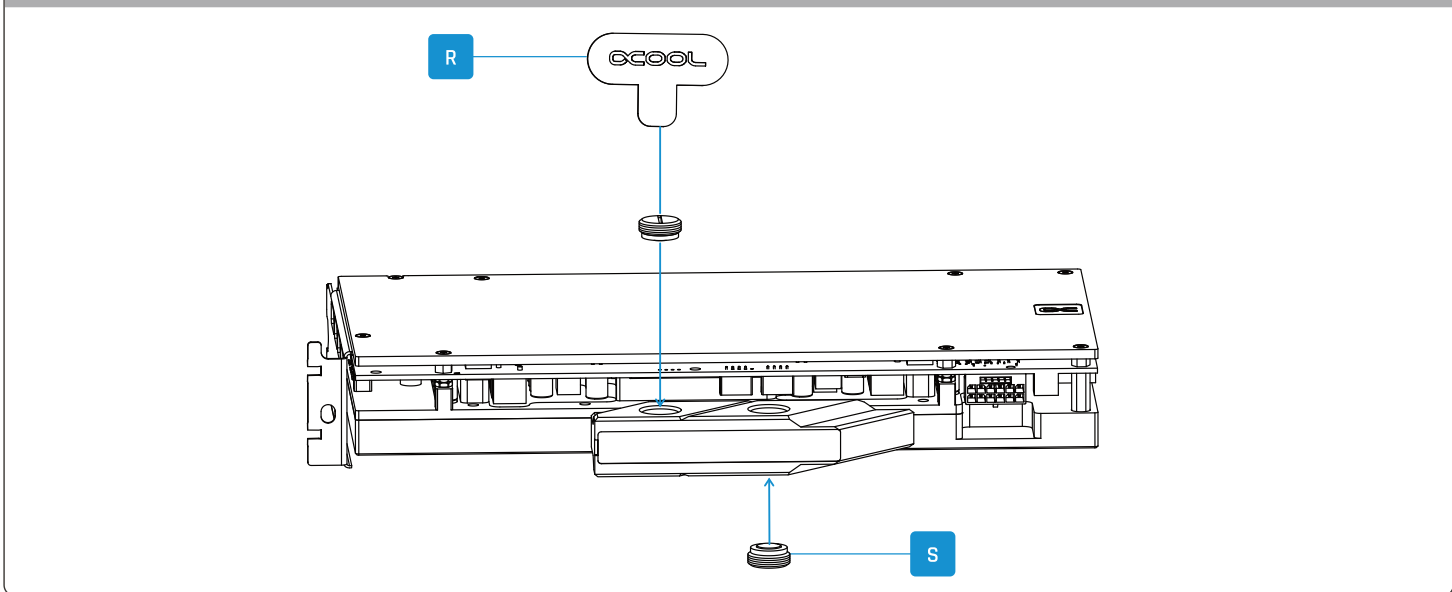

Need help?



Alphacool International GmbH  
 Marienberger Str. 1  
 D-38122 Braunschweig  
 Germany

Support: +49 (0) 531 28874-0  
 Fax: +49 (0) 531 28874 - 22  
 E-Mail: info@alphacool.com  
<https://www.alphacool.com>

We care!

