

FRIGUS Air 400 ARGB

THE COOLEST SPECTRUM

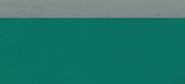
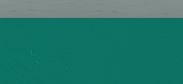

TOP COVER ARGB STRIP DESIGN

The design of ARGB strips on the top cover embellishes the aesthetics of the entire appearance.



ALL-BLACK THEME

The design of blackened heat sinks and cooper heat pipes take the beauty of FrigusAir 400 RGB to the next level.

SYNC WITH THE MOTHERBOARD READY FOR 16.8 MILLION OF CUSTOMED ARGB LIGHT EFFECTS

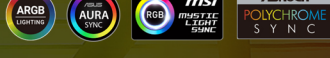

1

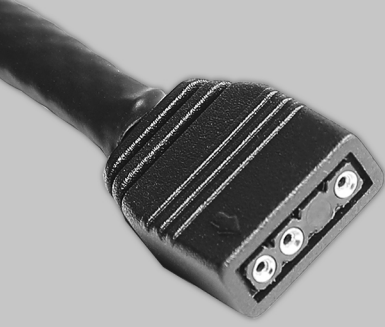

If your motherboard supports with 3-pin, 5V ARGB, you can plug in the included FrigusAir 400 ARGB 3-pin connector directly for motherboard sync.

2

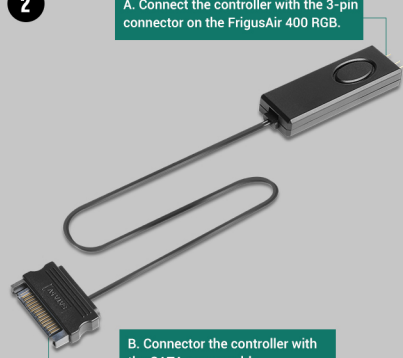

Sync with the Included Controller

INDIVIDUAL ARGB CONTROLLER INCLUDED

Make it much easier for you to choose the light effects you like.

Long Press: Power on / off
Single Press: Change the ARGB light effects

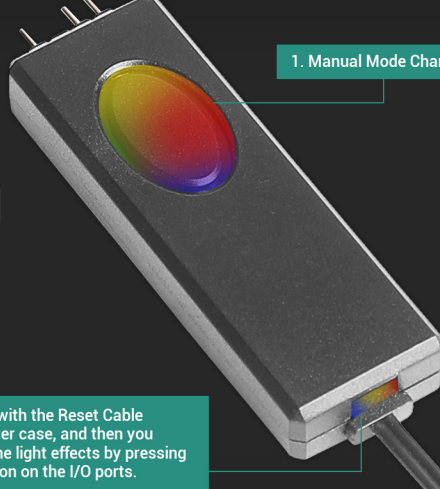

1. Manual Mode Change Button

2. Connect it with the Reset Cable in the computer case, and then you can change the light effects by pressing the reset button on the I/O ports.

REMOVABLE FAN

The fan is easy to be removed, make it more convenient for dusting and maintaining.



THE ACCESSORIES

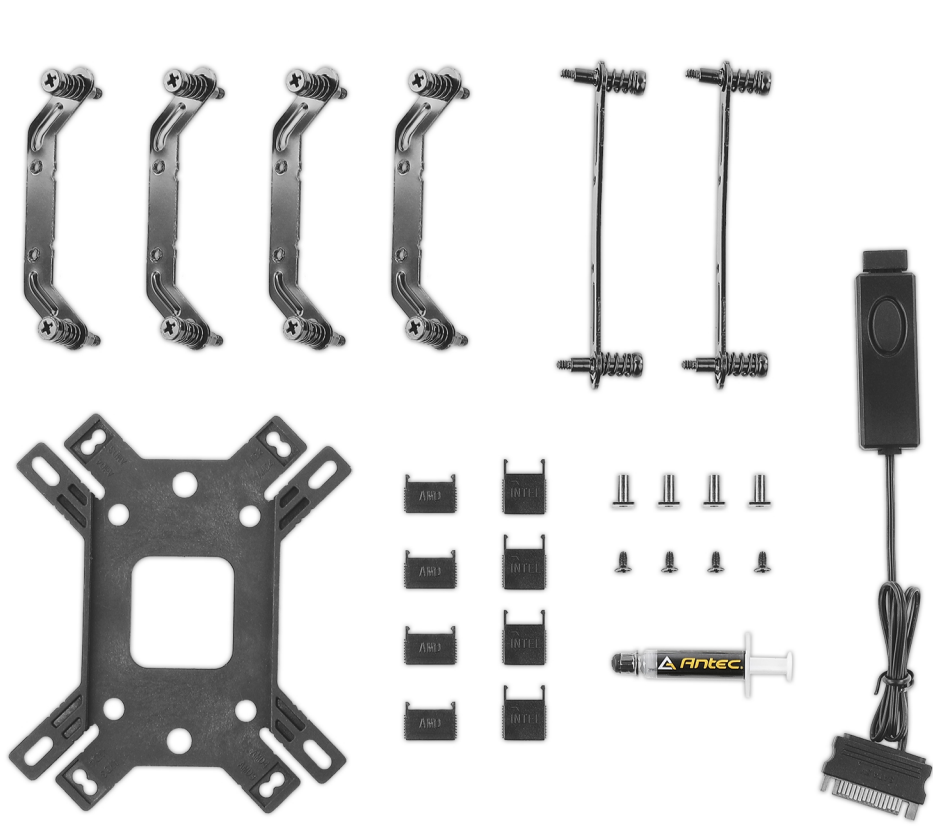

FRIGUS Air 400 ARGB

THE COOLEST SPECTRUM

Specification	
Cooling Type	Air cooling
Product Dimension	125 x 75 x 158 mm (DWH)
Fan Dimension	120 x 120 x 25 mm
Fan Type	PWM ARGB LED Fan
Fan Speed	800-1600 RPM (PWM) ± 10%
Airflow	77 CFM max.
Noise Level	20-36db (A)
Lifespan	40,000 hours
Connector	Fan: 4 pin ARGB: 3pin (Synchronizable with M/B)
Rated Voltage	12VDC
Rated Current	0.3A
Heat Pipe Dimension	Φ6mm
Heat Sink Material	4 Heat Pipes, Aluminum Fins
Socket Compatibility	Intel LGA 2066/2011-V3/1366/1151/1150/1155/1156/1700 AMD AM4/AM3+/AM3/AM2+/AM2/FM2+/FM2/FM1
Fan Controller	Included
Warranty	3 Years
UPC#	0-761345-74007-4

